

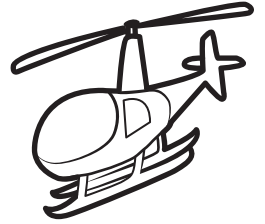

JOHN WAYNE AIRPORT ORANGE COUNTY

FUN GUIDE

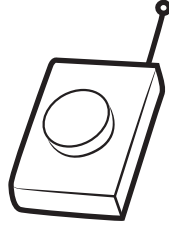

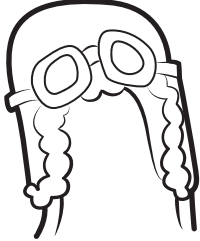
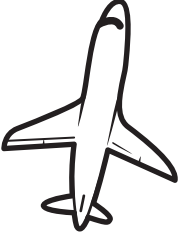
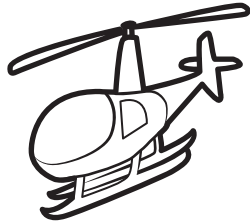
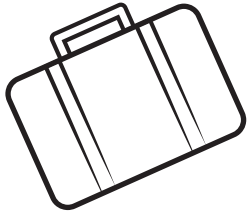

THIS BOOK BELONGS TO

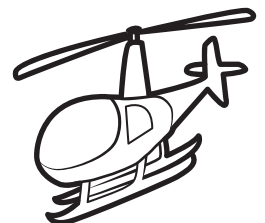
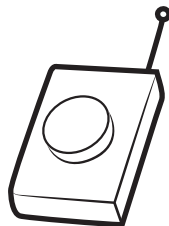
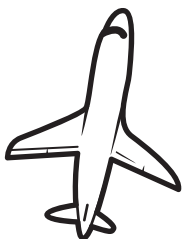
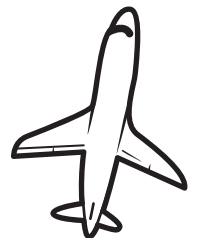
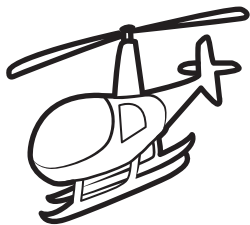
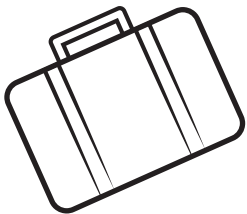
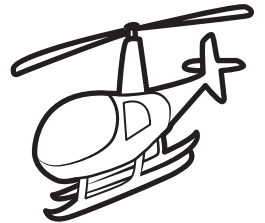
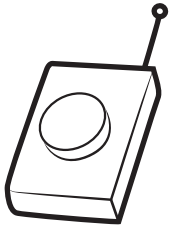
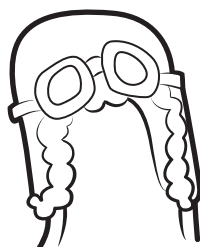
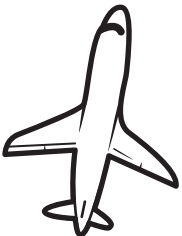
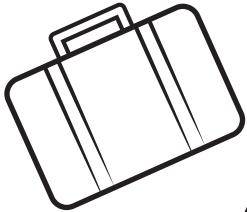

JOHN WAYNE AIRPORT

Welcome! This Fun Guide was made just for you. Our Airport is a very busy and interesting place. Learn a little about the Airport – like what kind of airplanes fly here – and about the people who make John Wayne Airport a safe and special place.

We hope you enjoy this Fun Guide – and your visit to John Wayne Airport. Please come back and see us soon!

Barry A. Rondinella
Airport Director

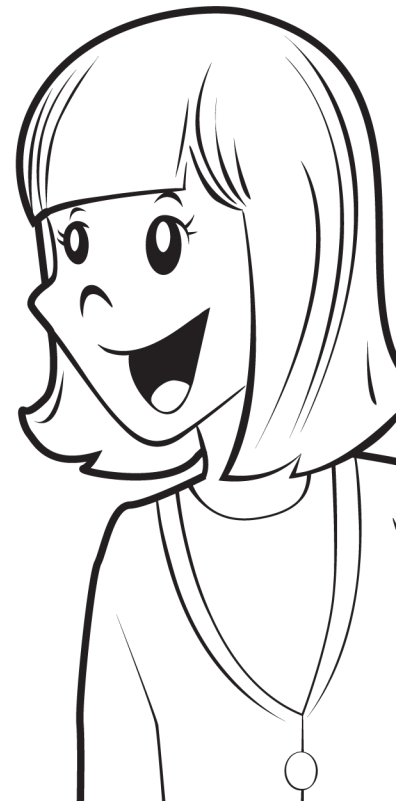

DRAWING

FUN

Draw my pilot's cap!

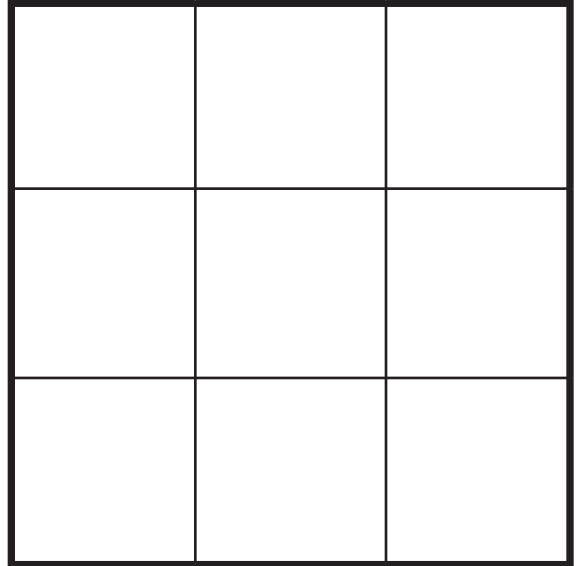
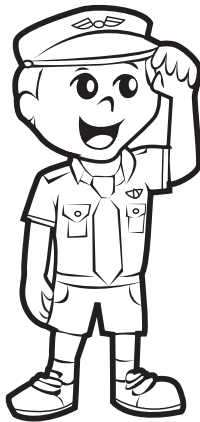
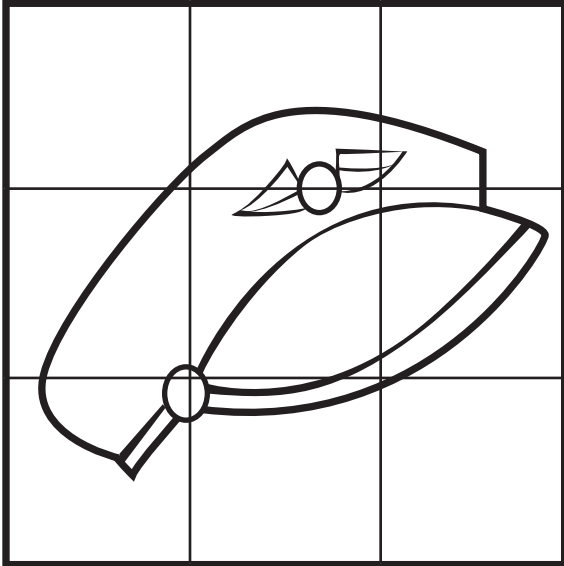

Draw my pilot wings!

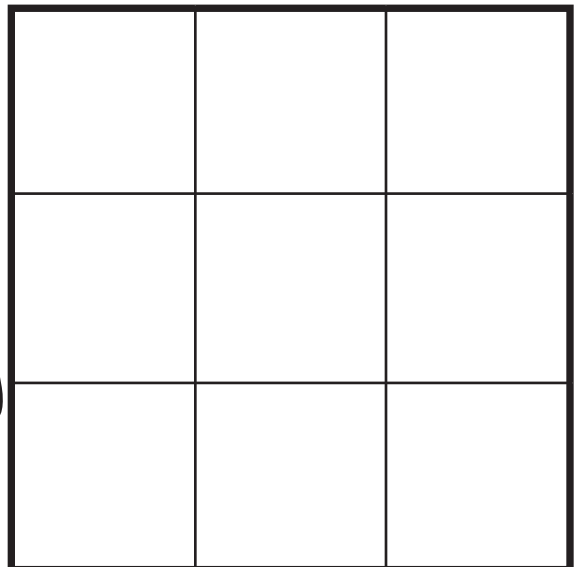
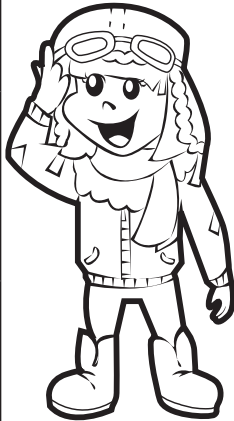
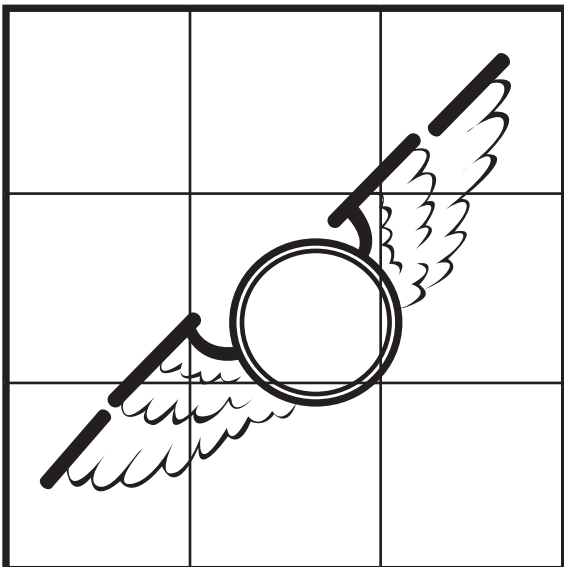

DESTINATIONS

Draw a line from a passenger to their destination.

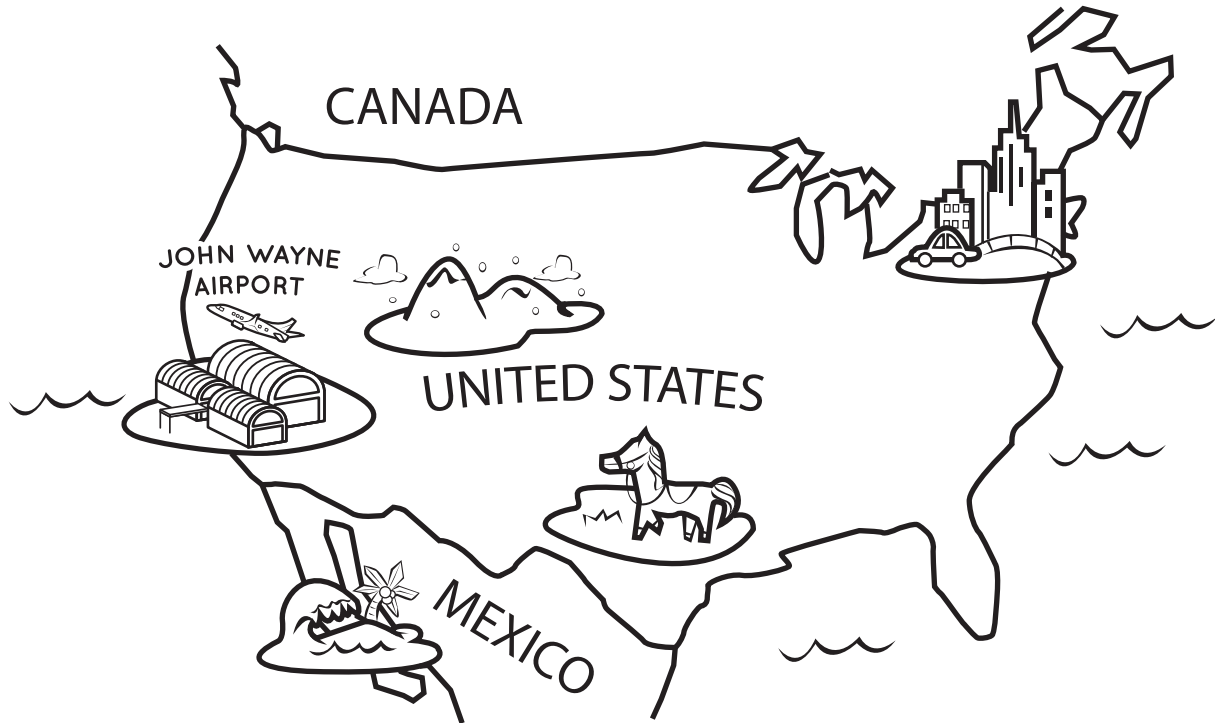

WHERE
ARE YOU
GOING?



WORD SEARCH



Find the words below!

A I T A E G I P E A I R
I E P L R E P C H W E E
P W K I N O N I E L G E
O I I R O N I G L N A L
Y N C N G O A E I O L N
G G P Y D G P D C N T L
N S K Y G O N I O F E T
O S F U R A W N P R N N
R A L P L A I O T A I L
T A D D H T A K E O F F
N T S A D I E C R K I N
O G L S T O O A A C D P

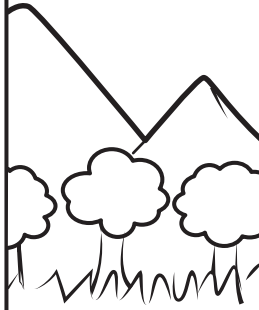
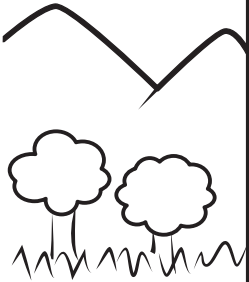

PILOT WINGS SKY
LUGGAGE ENGINE
PROPELLER TAIL AIR
WINDOW LANDING
TAKEOFF HELICOPTER

AERIAL MAP

405 Freeway

There's a lot happening at the Airport every day. John Wayne Airport has two runways: a 5,700-foot main runway (D) and a 2,887-foot runway (E). The main runway is used by the airlines to get you where you are going and the smaller one is for private planes that we call "general aviation."

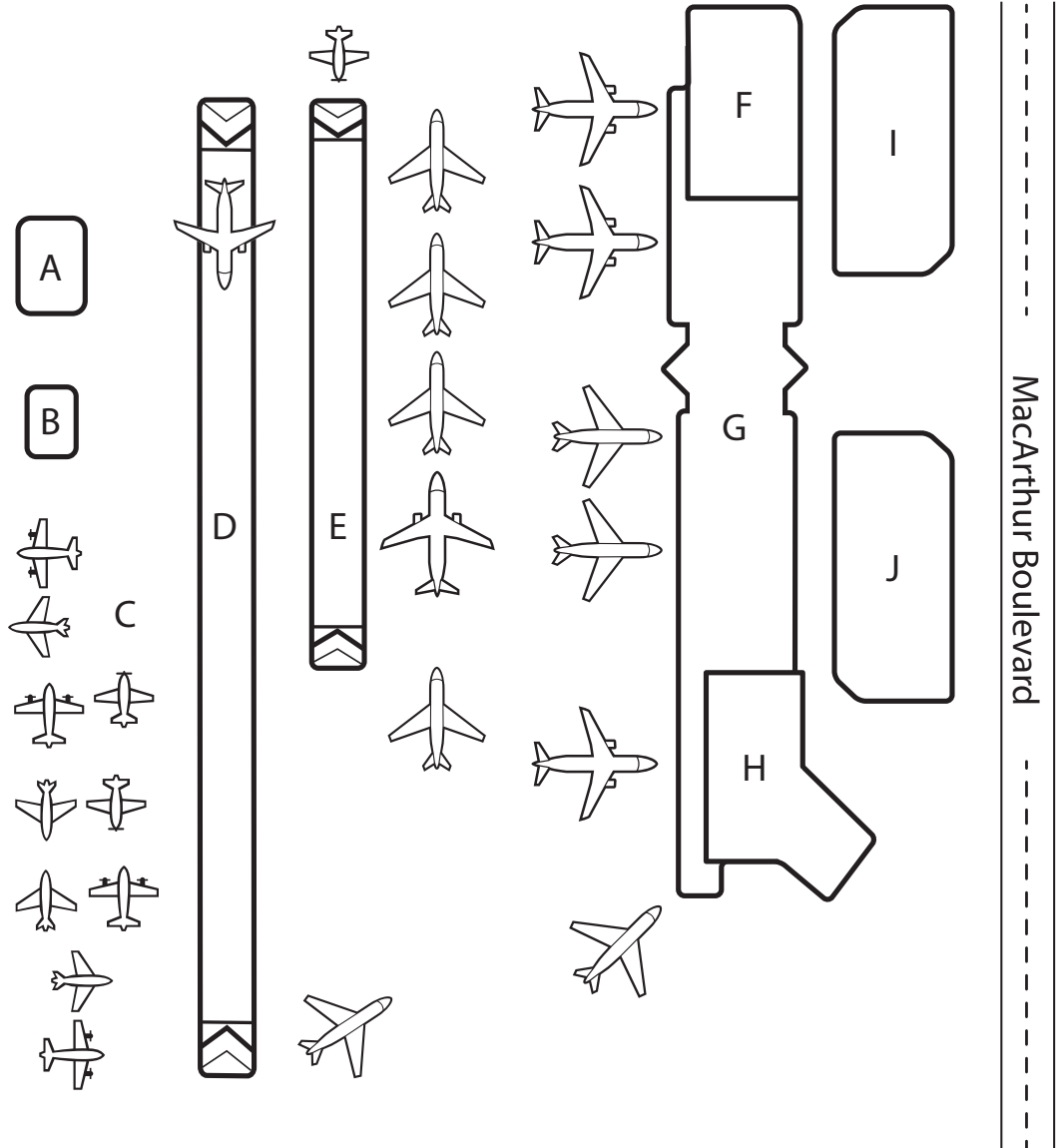
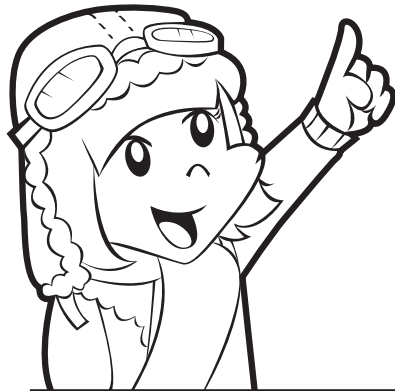

MacArthur Boulevard

73 Freeway

- | | | |
|-----------------------------|----------------------------|------------------------|
| A Fire Station | E General Aviation Runway | I Parking Structure A2 |
| B Air Traffic Control Tower | F Parking Structure A1 | J Parking Structure B2 |
| C General Aviation Parking | G Thomas F. Riley Terminal | |
| D Main Runway | H Parking Structure C | |

AIRCRAFT

AT JOHN WAYNE AIRPORT

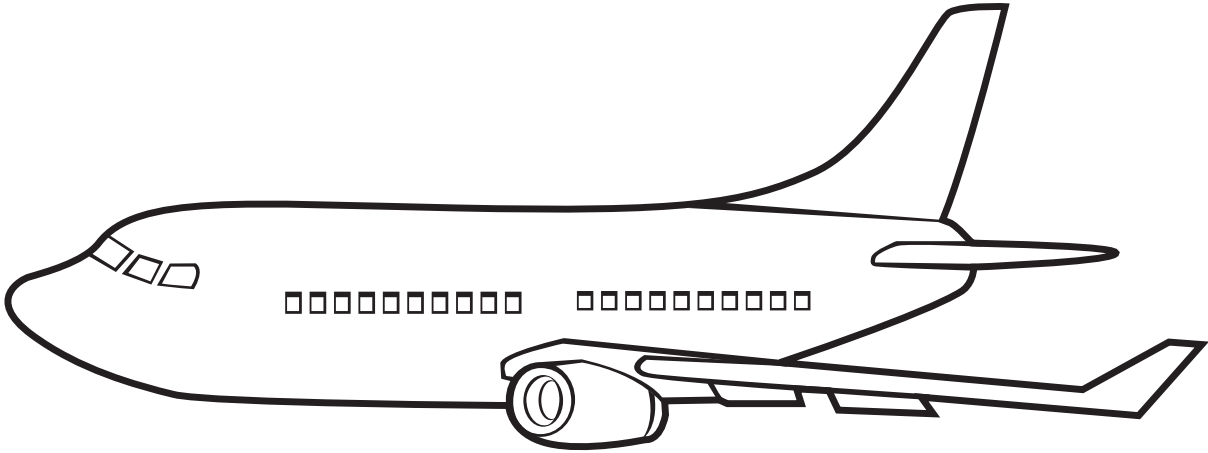

COMMERCIAL AIRCRAFT

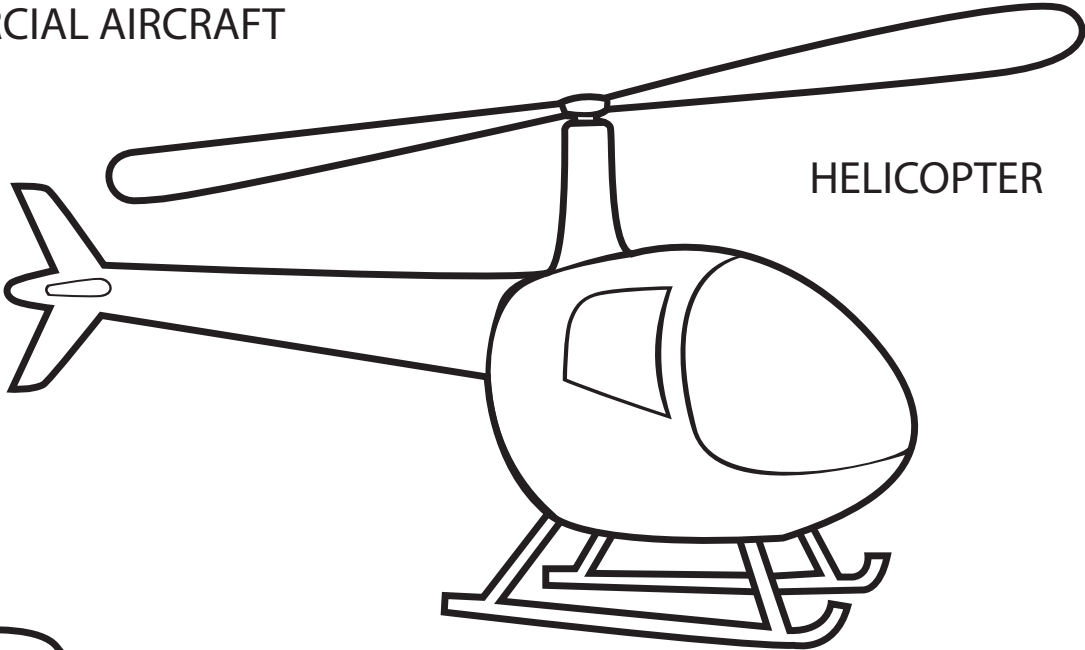

HELICOPTER

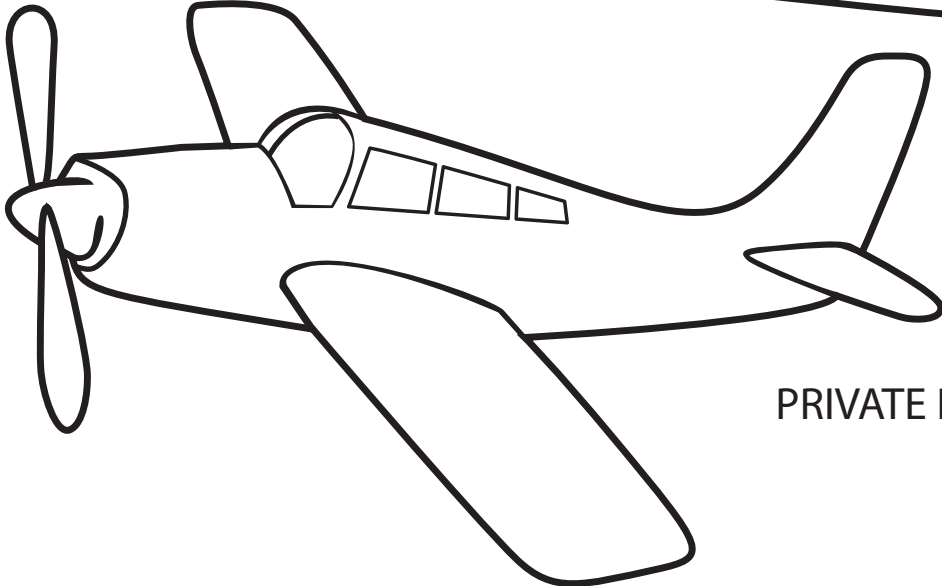

PRIVATE PLANE

TRAVEL CROSSWORD

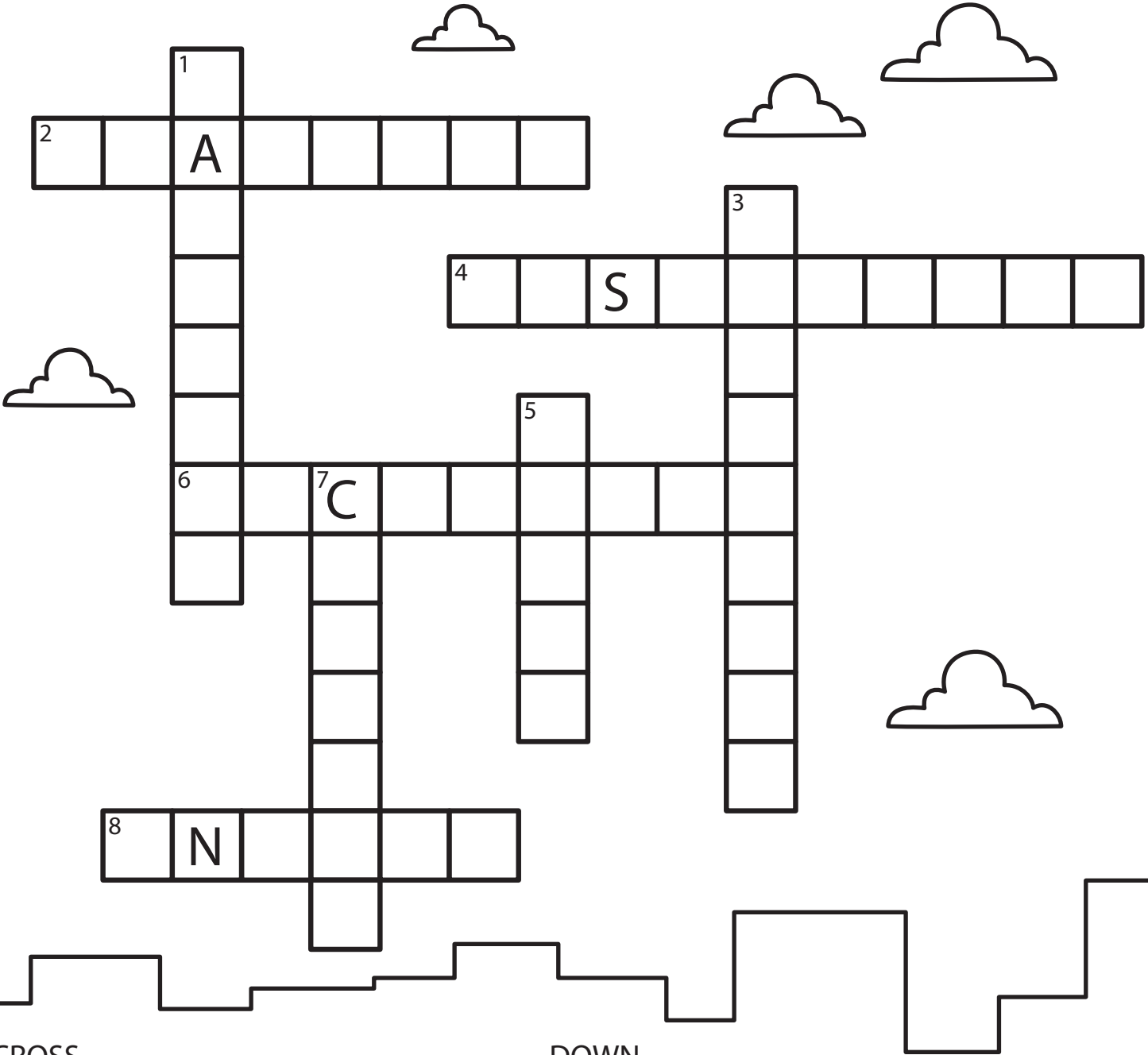
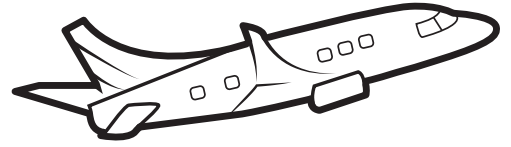

ACROSS

2. Keeps you safe in your seat
4. Another name for travelers
6. Moving stairs
8. Powers the plane

DOWN

1. Where you pick up your luggage after a flight
3. Arrival & _____
5. Part of the plane where passengers sit
7. Part of the plane where the pilot sits

UNSCRAMBLE THE AIRPORT TERMS



LENPA



GLEGUGA



OPTIL



NHJO NYEWA



SATROPPTS

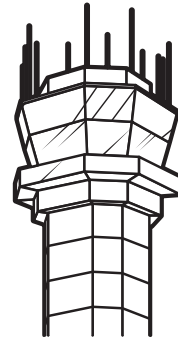

LCTRONO
OTWRE



AIRPORT POLICE



Help the Deputy find the leash to his four-legged partner.

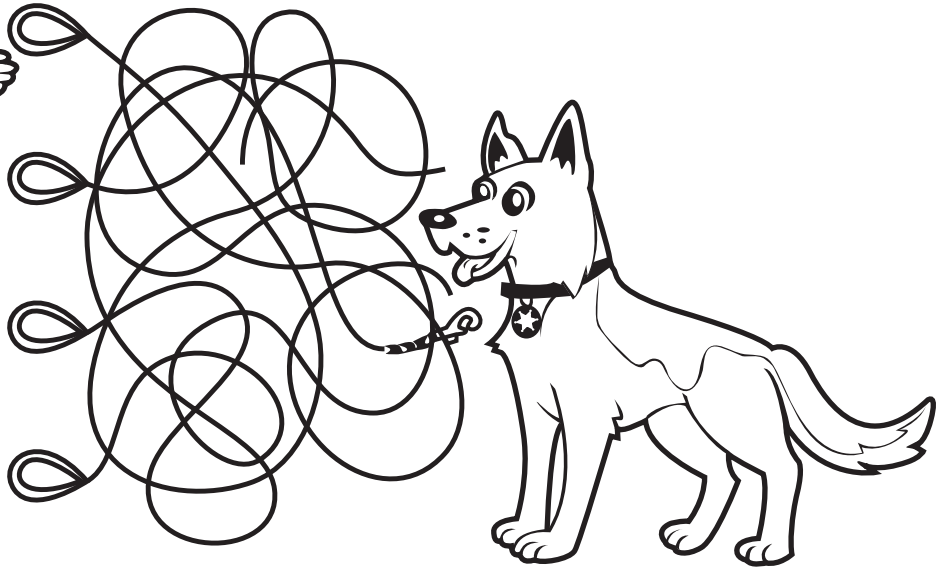

FIRE FIGHTER

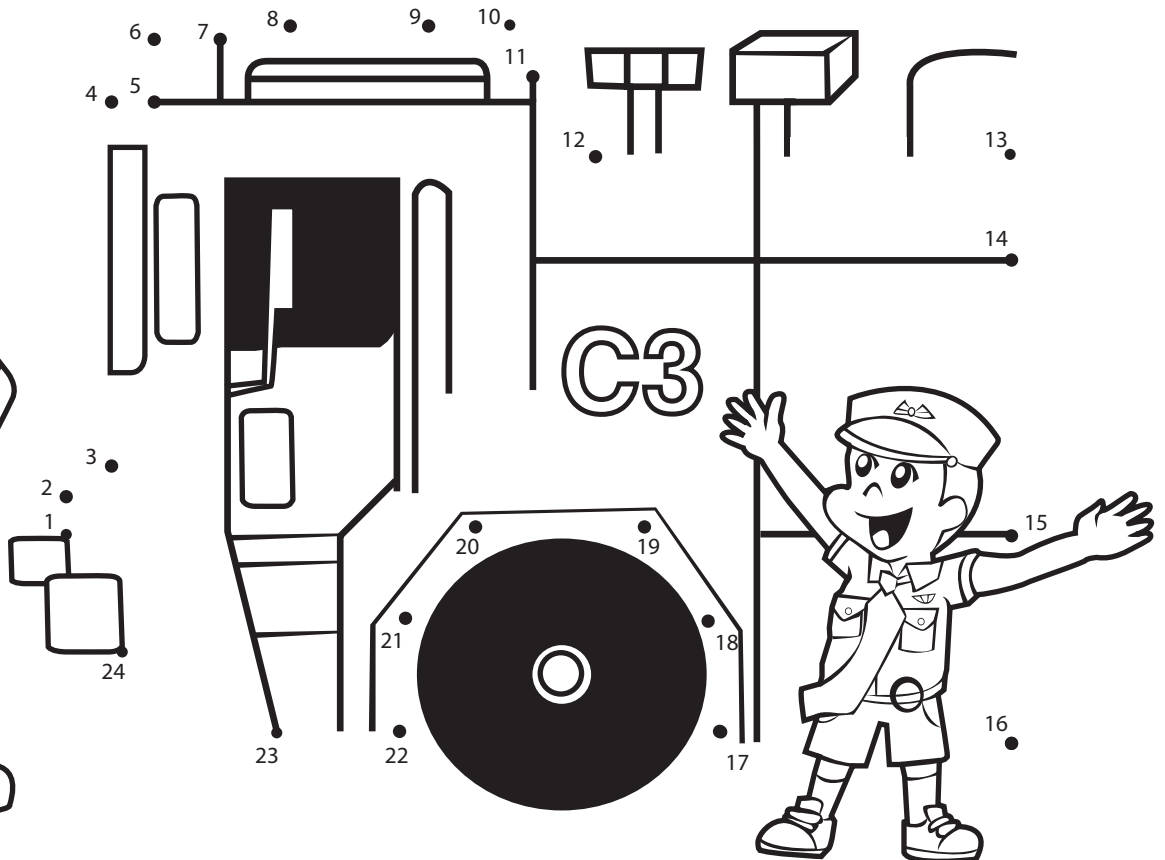

COLORING
FUN

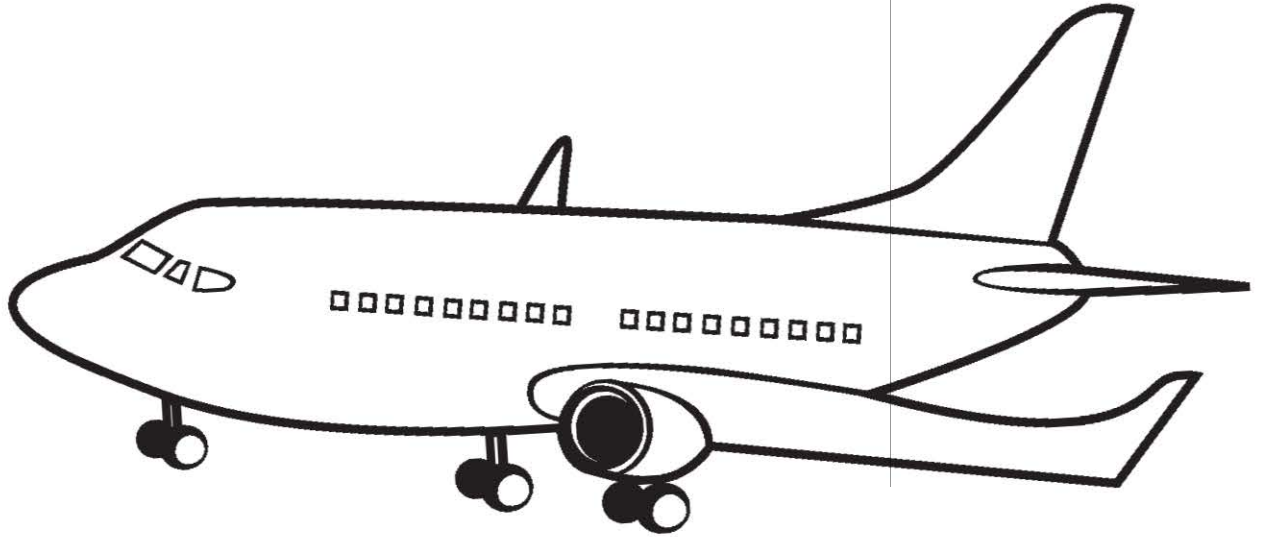

COUNT THE FOOD

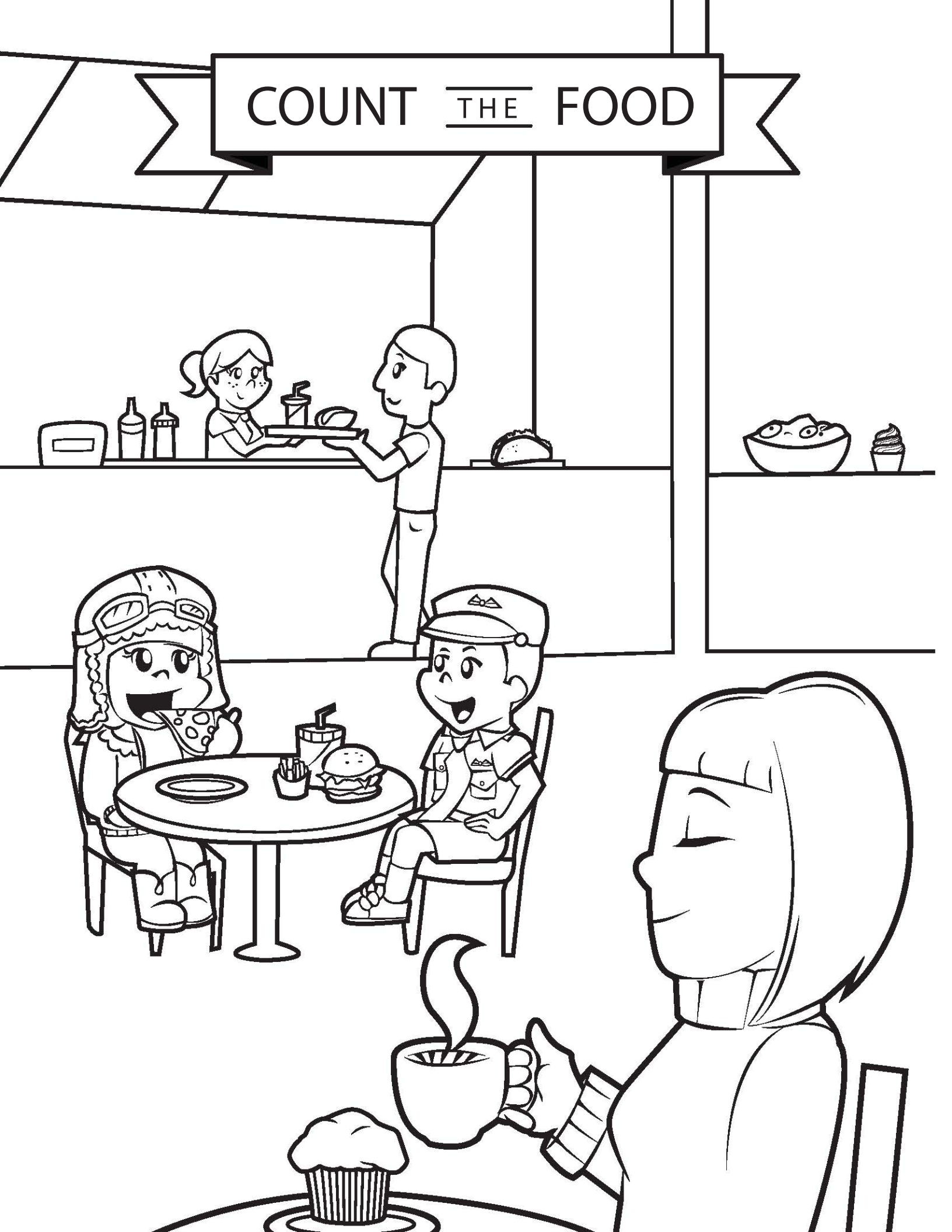

TIC-TAC-TOE

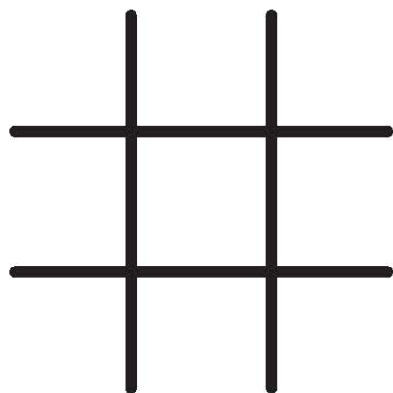
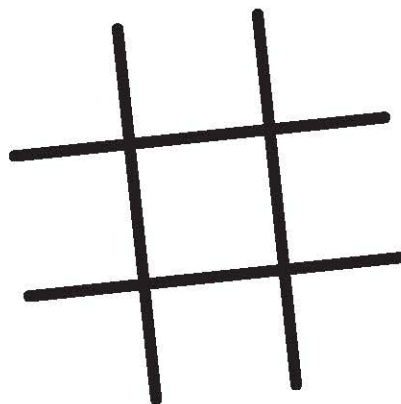
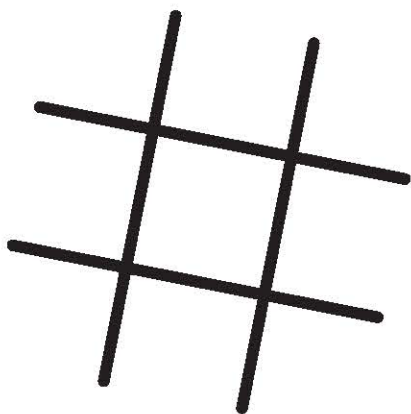
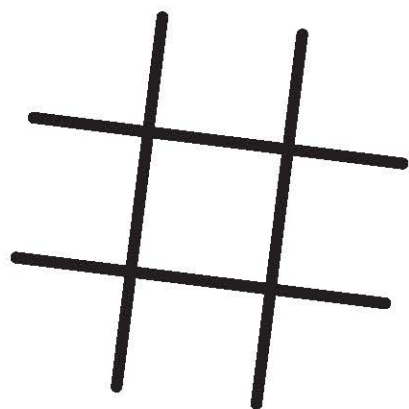
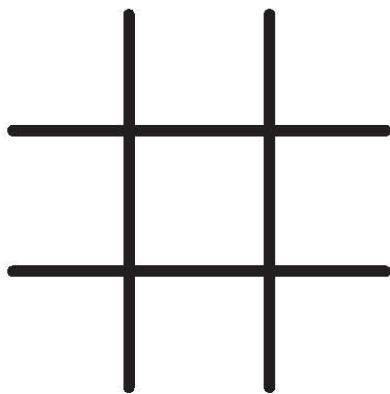
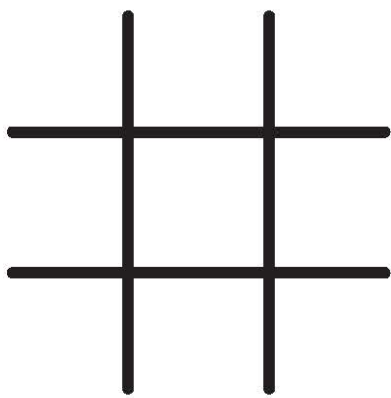

PILOT'S ALPHABET

Each letter in the alphabet has a name pilots use to communicate with the Control Tower to be sure they understand each other over the radio.

ALPHA	FOXTROT	KILO	PAPA	UNIFORM
BRAVO	GOLF	LIMA	QUEBEC	VICTOR
CHARLIE	HOTEL	MIKE	ROMEO	WHISKEY
DELTA	INDIA	NOVEMBER	SIERRA	X-RAY
ECHO	JULIET	OSCAR	TANGO	YANKEE
				ZULU

JULIET OSCAR HOTEL
NOVEMBER WHISKEY ALPHA YANKEE
NOVEMBER ECHO ALPHA INDIA ROMEO
PAPA OSCAR ROMEO TANGO WHISKEY
ECHO LIMA CHARLIE OSCAR MIKE
ECHO SIERRA YANKEE OSCAR
UNIFORM

Use the pilot's alphabet to
crack the secret code above:

— H — — Y —
— R — — —
— — — S — — U



B

A

INSTRUCTIONS:

Fold **A** to **A**, **B** to **B**
and so on until done.

Enjoy your new airplane!

B

A

D

C

E

E

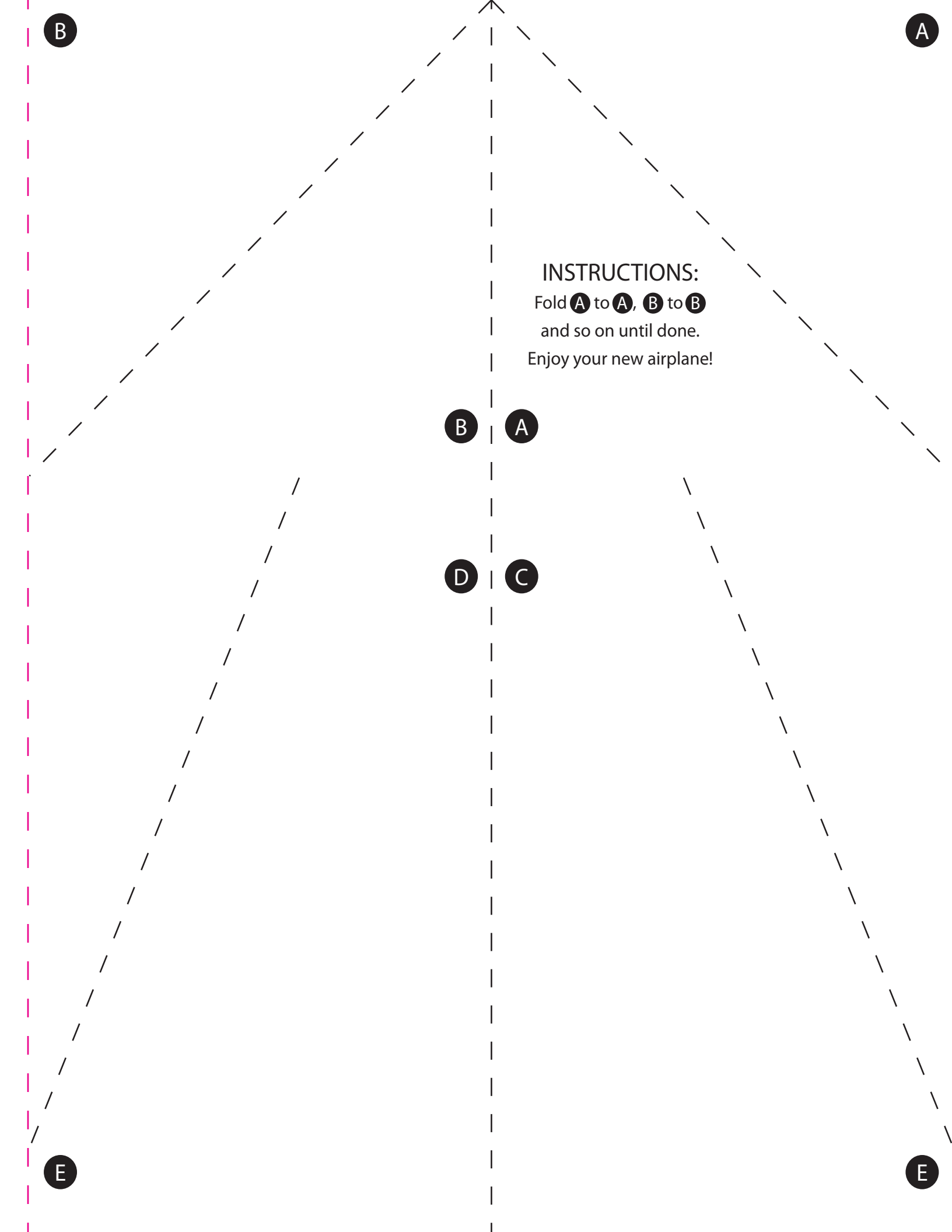

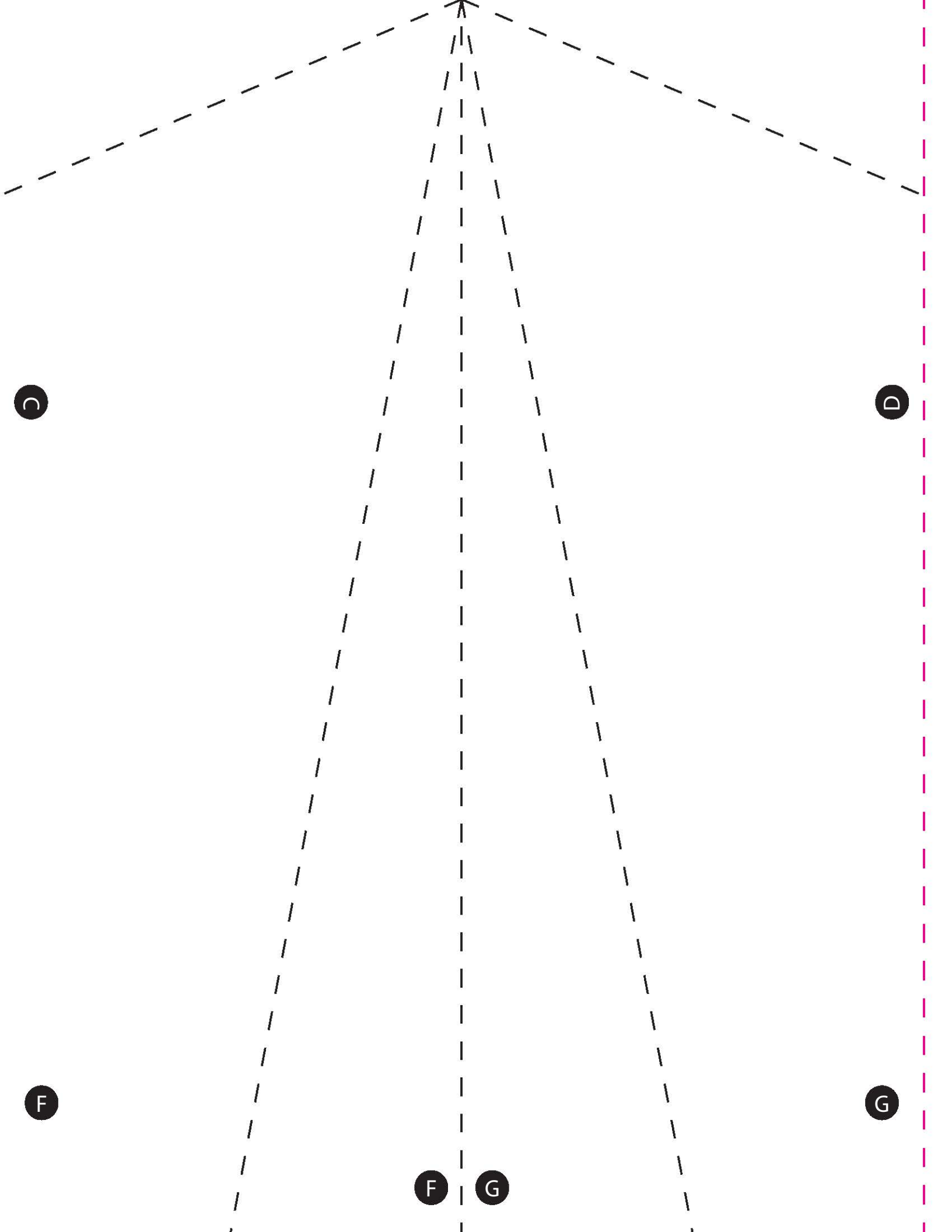

WHAT'S IN A NAME?



Named for one of Orange County's earliest aviation pioneers, the Airport started as "Eddie Martin Airport" in 1923. In 1941, the County of Orange built a replacement airfield nearby which became the "Orange County Airport."

In 1979, the Orange County Board of Supervisors renamed it "John Wayne Airport, Orange County" to honor the late actor and local resident.



In 1990, the Board of Supervisors named the newly constructed terminal building in honor of Fifth District Supervisor Thomas F. Riley in whose district the Airport was located.

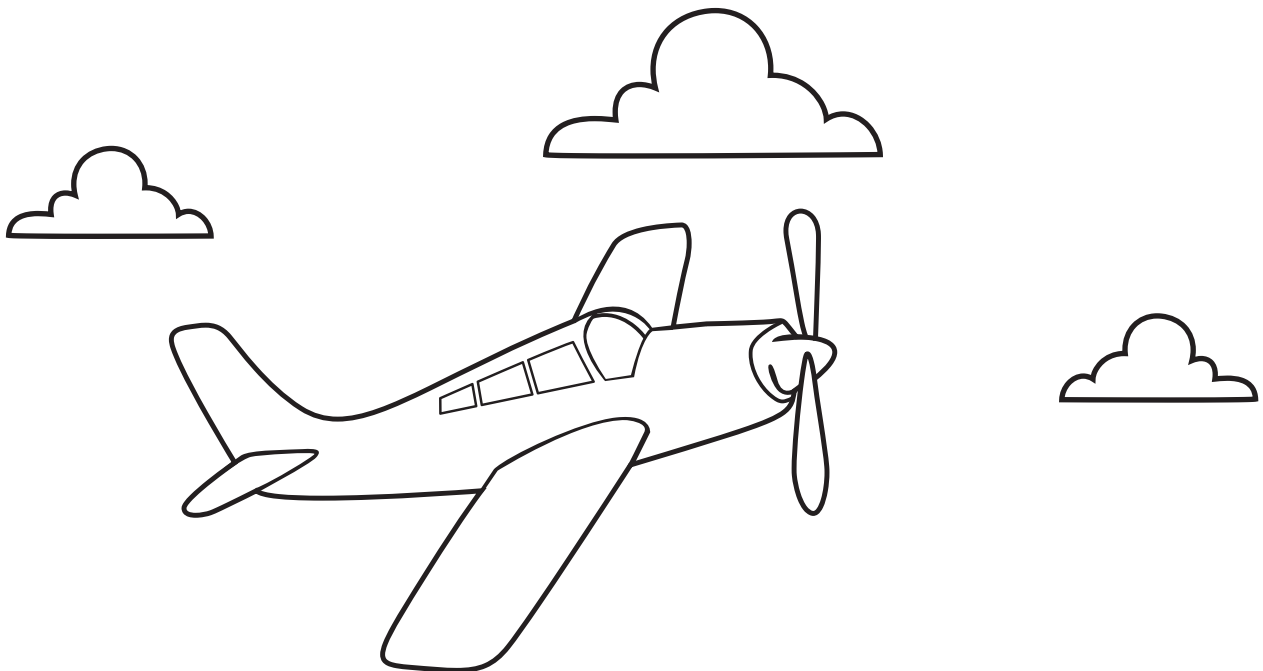

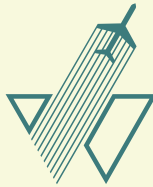



JOHN WAYNE
AIRPORT
ORANGE COUNTY

FOR MORE INFORMATION
ABOUT JOHN WAYNE AIRPORT VISIT
OCAIR.COM

18601 AIRPORT WAY
SANTA ANA, CA 92707
(949) 252-5200
INFO@OCAIR.COM

 [johnwayneairport](https://www.facebook.com/johnwayneairport)

 [@johnwayneair](https://twitter.com/johnwayneair)

 [@johnwayneair](https://www.instagram.com/johnwayneair)

